



Sen Bai

抗震支架 · 管廊支架

安全 / 高效 / 节能 / 美观

抗震支架 · 管廊支架

邯郸市森柏紧固件有限公司

Handan senbai Fastener Co., Ltd

联系电话:133-7300-5765(微信同步)

厂址:河北省 · 邯郸市 · 永年区 · 中国国际标准件产业城

邯郸市森柏紧固件有限公司

Handan senbai Fastener Co., Ltd

企业简介 >>> COMPANY INTRODUCTION

邯郸市森柏紧固件有限公司是一家从事抗震支架、成品支架、预埋槽的研发生产、销售工程设计以及施工为一体的专业公司。同时公司还有专业的技术团队为您的项目提供CAD绘图，BIM管线综合支架排布，支架结构系统的应力载荷计算，以及为您和您的最终用户提供值得信赖的支吊架系统解决方案。

公司产品广泛应用于工矿企业，民用建筑，电力电子，轨道交通等行业，旨在为地震灾害中的给水排水、消防、空调、燃气电力等机电工程提供必要的防护，为项目提供专业化解决方案。

公司位置紧临京广铁路107国道和京深高速公路，交通十分便利。邯郸市森柏紧固件有限公司一流的设备,专业的技术团队，励精图治、开拓创新、坚持以国家标准力指导，以客户需求为依据,为您提供高质量的产品、主要产品:抗震支架、管廊支架抗震配件、U型管束、O型管束、P型管束、AB铰连接、C型钢、塑翼螺母、弹簧螺子、角码、扣垫、后扩底锚栓、加强筋V型加紧装置等产品。企业秉承"以质量求生存、以信誉求发"的经营理念、以先进精增的生产工艺、强大完备的生产能力、完善齐全的检测手段、努力在紧固件行业中精心打造自己的品牌。

邯郸市森柏紧固件有限公司将全理为您提供真诚的服务、欢迎新老客户来电垂询、参观考察洽谈合作!

SEISMIC SUPPORT AND HANGER SYSTEM

抗震支吊架系统 高品质 实力厂家



诚信共赢专业卓越

森柏抗震系统专家

Senbo seismic system expert



中国建筑机电抗震先锋

抗震支吊架、装配式支吊架、管廊支吊架

公司产品广泛应用于工矿企业，民用建筑，电力电子，轨道交通等行业，旨在为地震灾害中的给水排水、消防、空调、燃气电力等机电工程提供必要的防护，为项目提供专业化解决方案。

抗震支架形成图



DN200以上单管侧向抗震支架

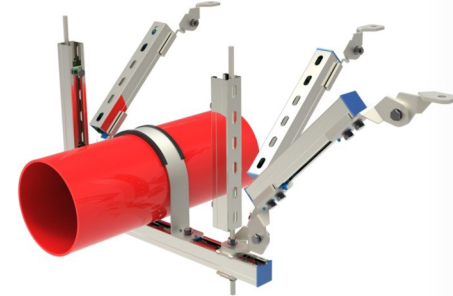

DN200以上单管双向抗震支架

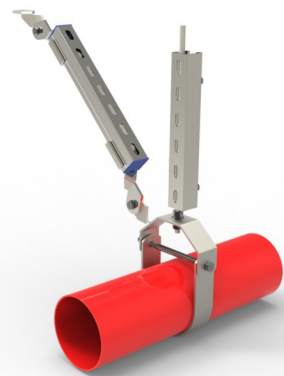

DN200以下单管侧向抗震支架

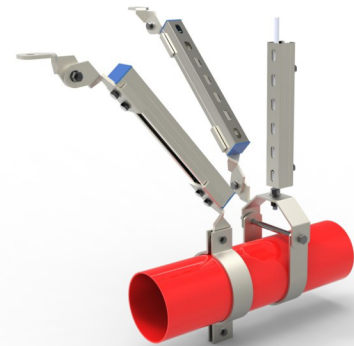

DN200以下单管双向抗震支架

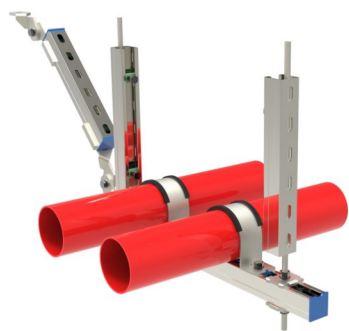

多管侧向抗震支架

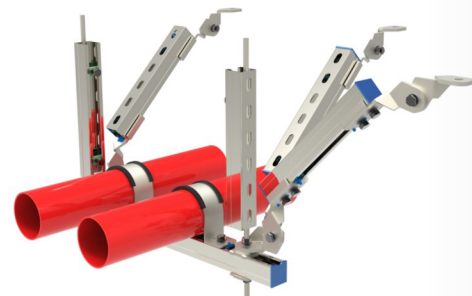

多管双向抗震支架

抗震支架形成图



电缆桥架侧向抗震支架

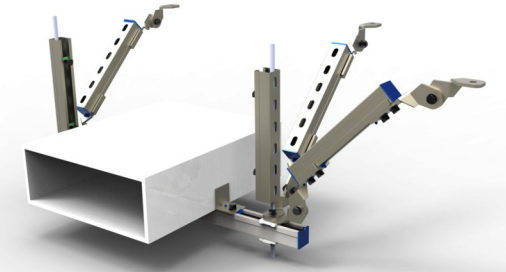

电缆桥架双向抗震支架

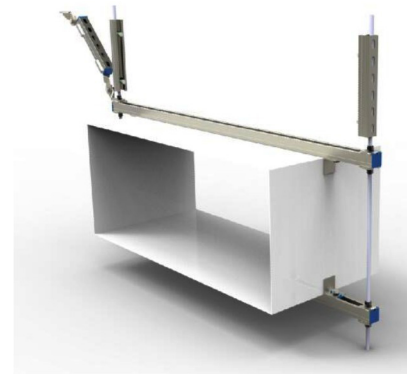

矩形风管侧向抗震支架

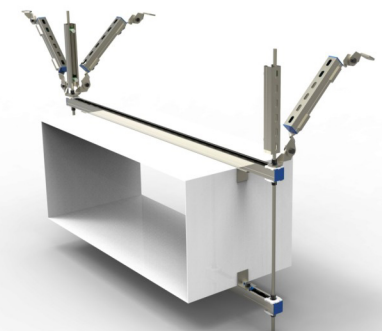

矩形风管双向抗震支架

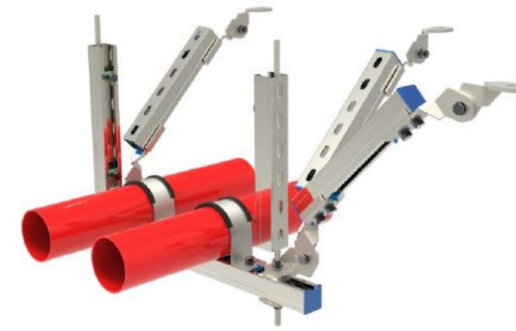

双管多向抗震支架

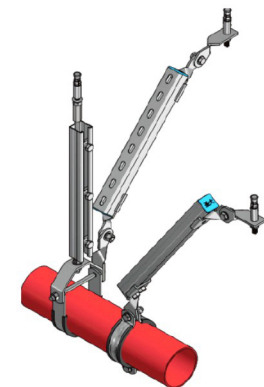

单管侧纵向抗震支架

抗震支架形成图

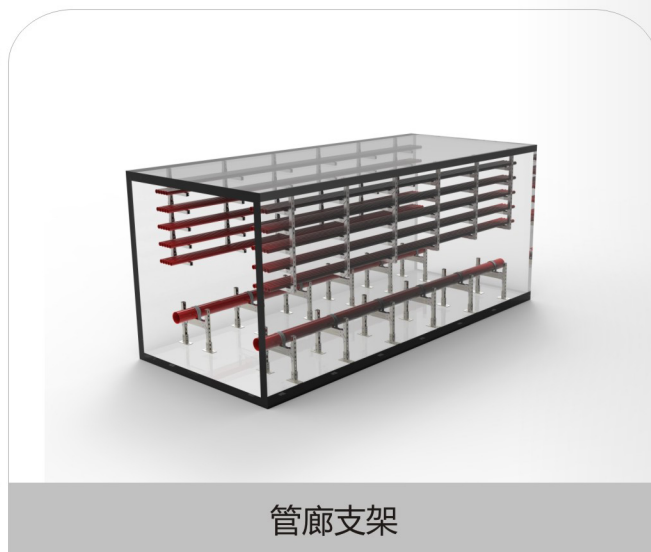
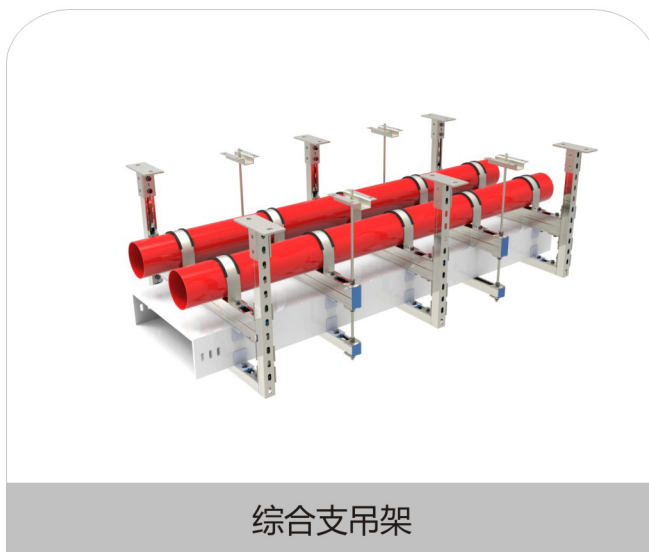
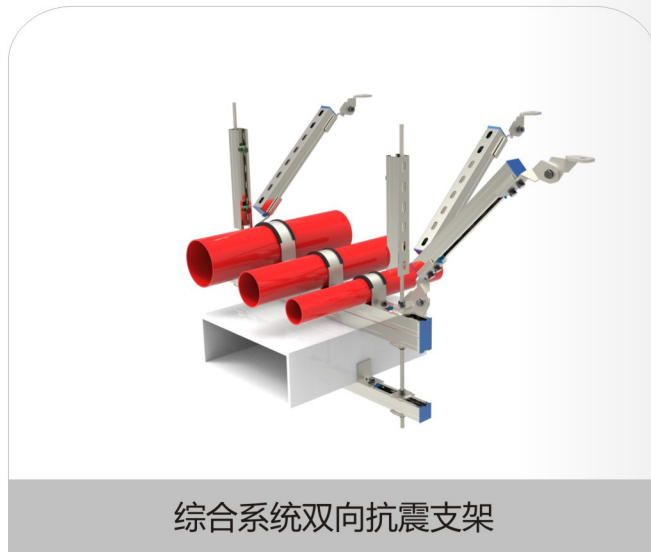
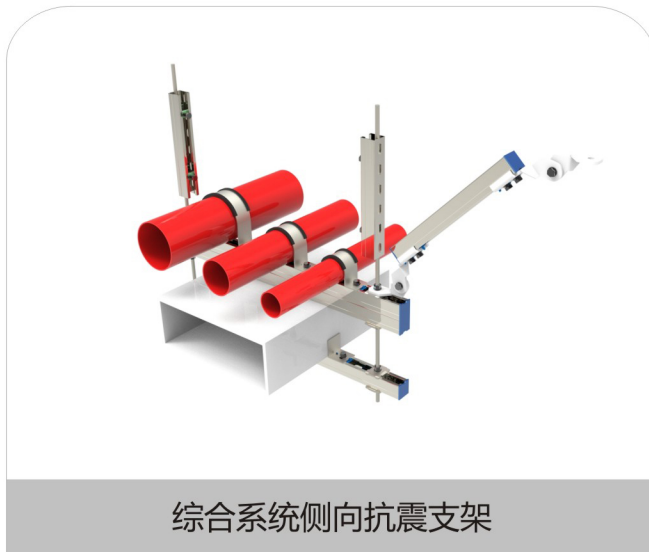
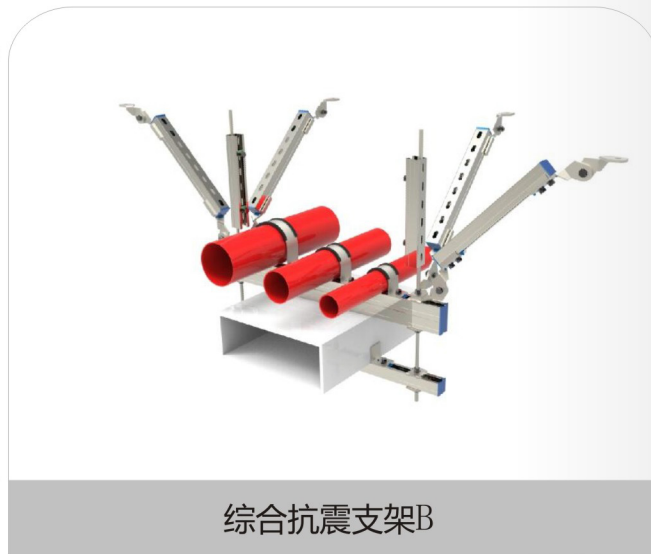
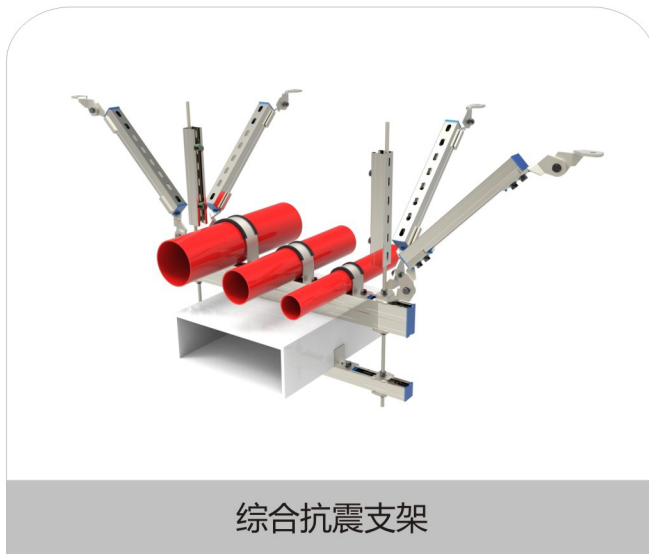

抗震支架形成图

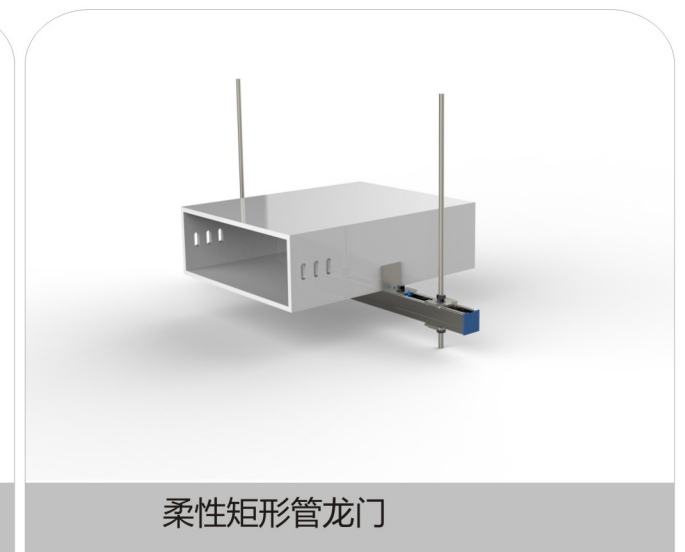
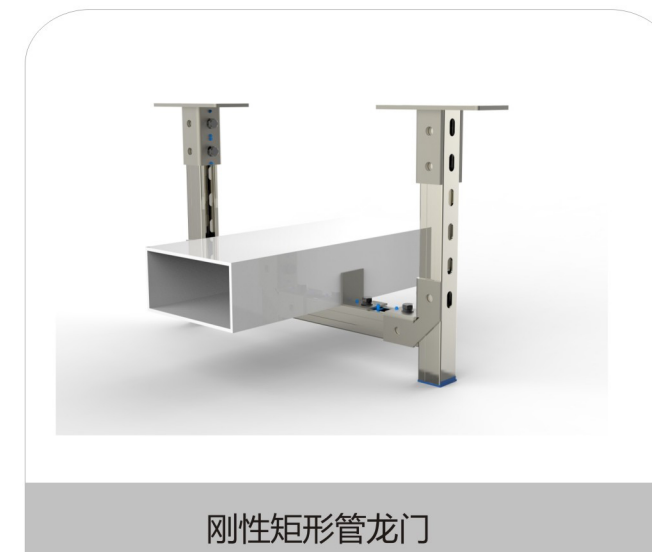
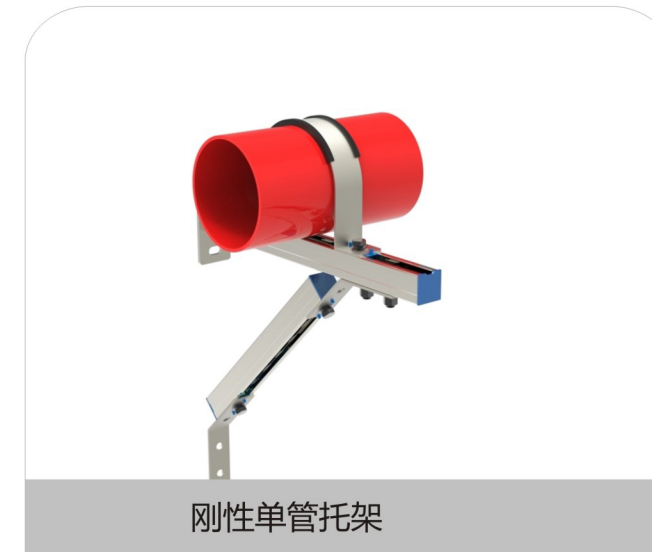

抗震支架形成图

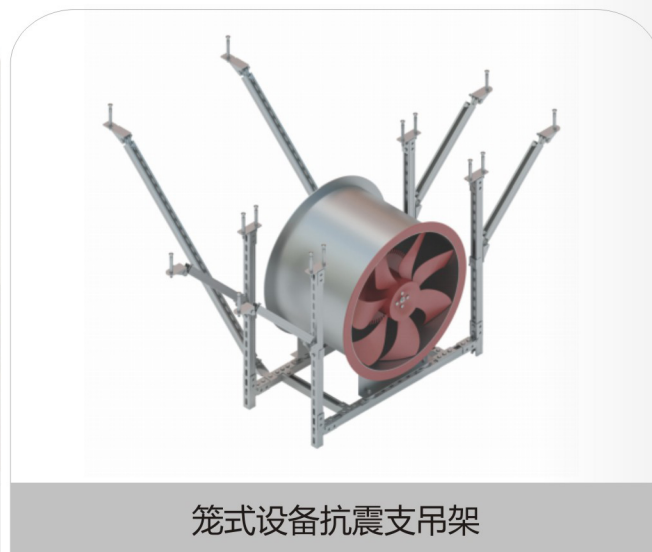
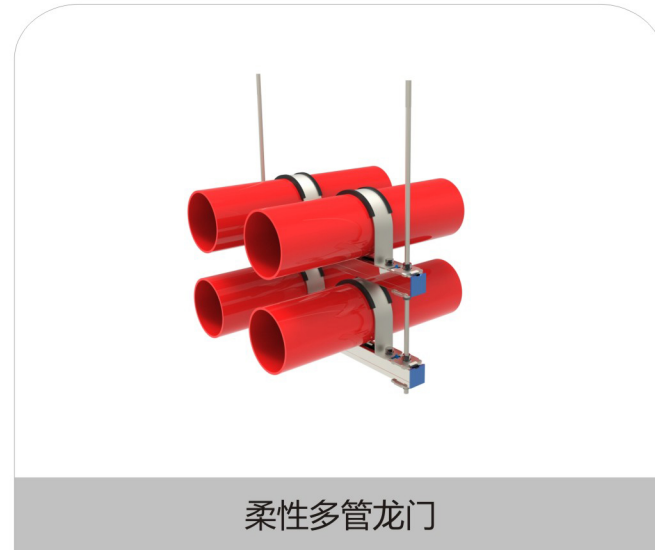
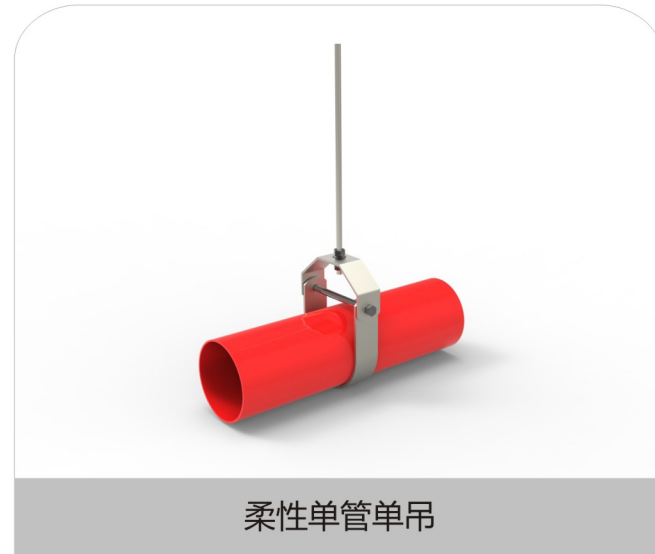



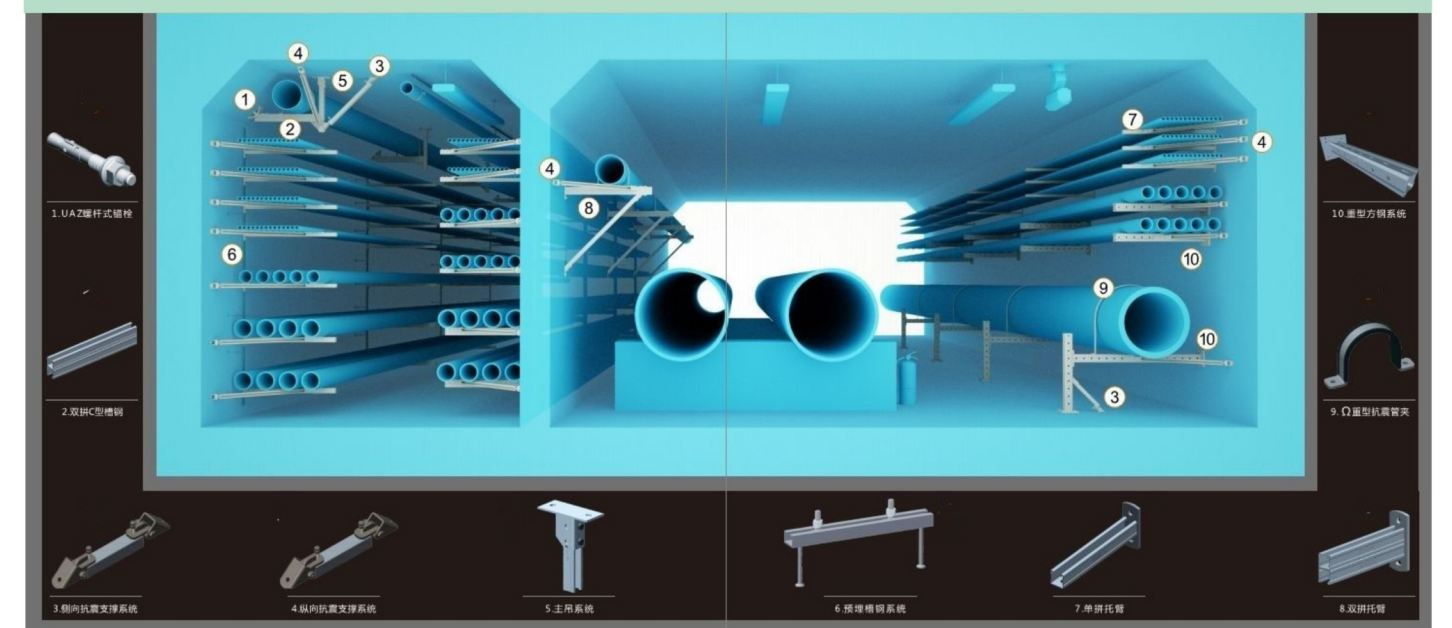
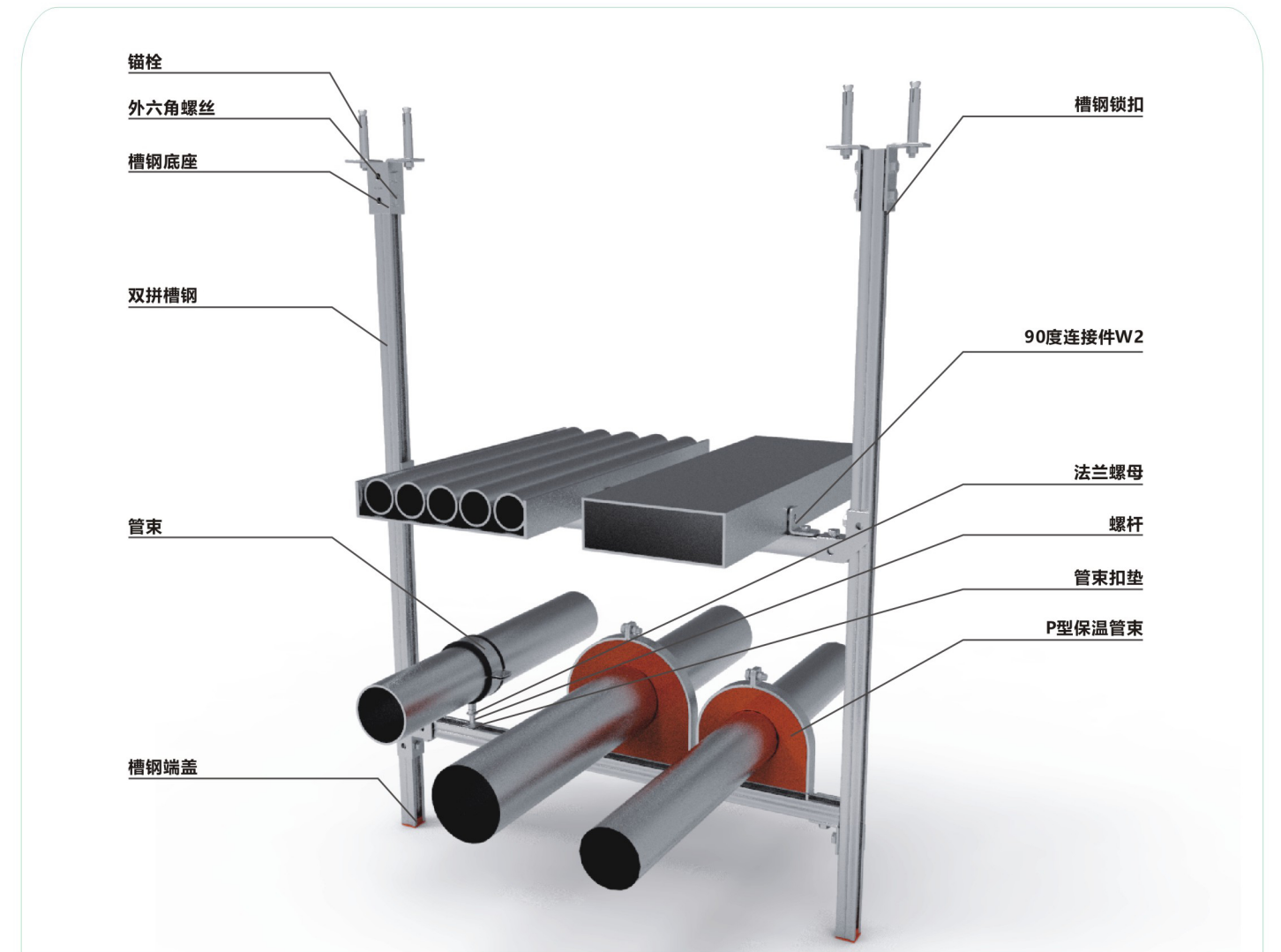







成品支吊架系统





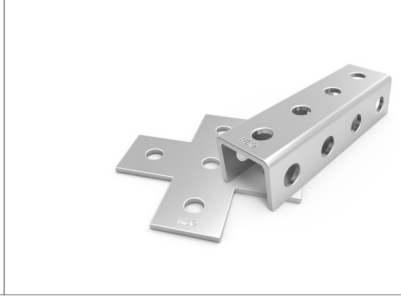









配件系列

单面槽钢	双拼槽钢	单面槽钢
		
双拼槽钢	单面槽钢托臂	单面槽钢托臂
		
双拼槽钢托臂	斜撑	预埋槽钢
		
预埋槽钢	槽钢底座	可调式槽钢底座
		
槽钢锁扣	槽钢端盖	螺杆端盖
		

配件系列

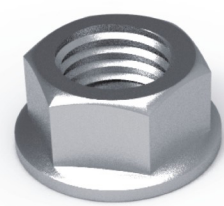
钢结构梁夹	三维连接件	槽钢扣件
		
90度角连接件	45度角连接件	135度角连接件
		
平面连接件		
		
活动斜拉	滑动支座	槽钢扣板
		
管束扣垫	螺杆接头	外六角螺丝
		

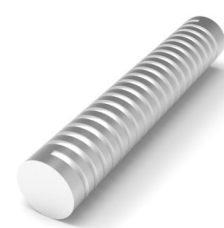
配件系列

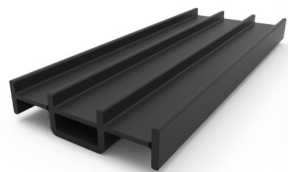
轻型管束	标准管束	重型管束
		
超重型管束	高温管束	P型管夹
		
P型保温管束	风管管束	风管管束
		
法兰螺母	外六角螺母	圆形垫片
		
螺杆	螺纹管	槽钢橡胶垫
		

配件系列

U型丝	减震器	弹簧减震器	弹簧减震器
			
带齿带弧型热轧槽钢	带齿热轧预埋槽钢	单面槽钢托臂	冷弯预埋槽
			
后扩底锚栓	穿透式锚栓	C型钢边盖	螺杆盖帽
			
T型螺栓	铸铁虎口夹	连接件C	连接件B
			

安装实例效果图

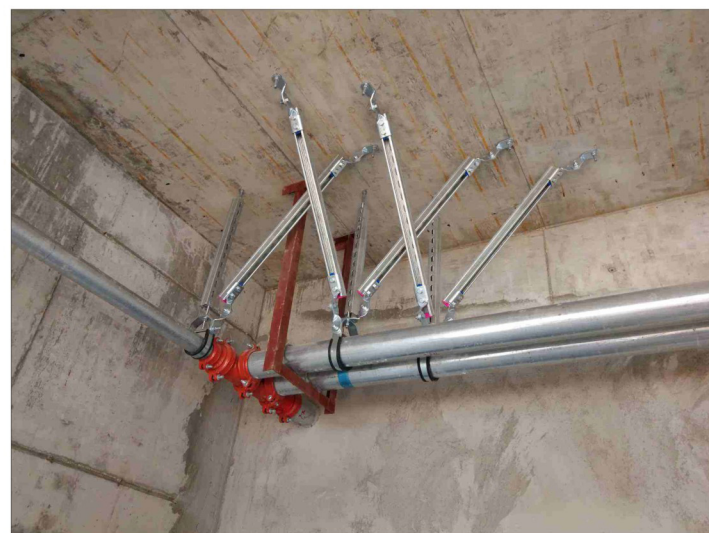

安装实例效果图

